

Pipe inspection system

Operation Manual



Read this Operation Manual carefully before using this tool.

INTRODUCTION

The pipe inspection system is a powerful set of tools that, helps you locate and diagnose problems in a pipeline system.

The system is widely used in inspections of Sewer, central air conditioning, chimney, plumbing, building, cable pipe and pipes ventilation systems and other places.

GENERAL SAFETY RULES

Precautions

Read all safety warnings and instructions. Failure to follow warnings and instructions may result in electric shock, fire and/or serious injury.

WARNING

1. Save this operation manual for future reference.
2. Do not operate this devices in explosive atmospheres, such as in the presence of flammable liquids, gases, hazardous chemicals, superheated liquid or heavy dust. It may create sparks which may ignite the dust or fumes.
3. The camera head and the push cable are waterproof, however, the battery pack, DVR and connector cable are not. Do not expose them to water or rain. This increases the risk of electrical shock.
4. Avoid using the device in environments of extreme cold, heat or humidity as it may damage the device.
5. Do not drop or press hard on the device.
6. Always backup your data before connecting your SD memory card to this system. The manufacturer is not responsible for any data of damage on your SD memory card for any reason.
7. Do not disconnect the unit while recording or playing back. It may damage the unit and/or the SD memory card.
8. Only qualified person are allowed to repair this device. Service or maintenance performed by unqualified person could result in injury.
9. Do not use this device in places where there is high voltage equipment. The device doesn't contain high voltage protection and isolation.
10. Check or maintain this device regularly, repair it or replace new parts if there is any damage.

APPLICATION AND KNOW YOUR TOOL

Application

Suitable for pipes at diameter of 25mm-120mm. Ability to go through 90° bend places with diameter at 50mm.

Know Your Tool

The pipe inspection system includes the following four main parts: Camera head, cable reel, battery pack and DVR.

The camera head includes 12 high-light white LEDs and a highly scratch-resistant sapphire lens cover; this coupled with stainless steel housing allow the camera to withstand repeated hits in various pipes.

Flexible stainless steel spring and associated components make the camera head possible to go through bend pipes. Also the cable reel is mounted and rotatable in the case therefore the fiberglass rod cable can be pushed in and out without the need to hold the reel. Further, the battery pack provides power supply for the system and the DVR monitor can record video and take photos.

Camera Head

1. SAPPHIRE LENS
2. WHITE LEDS
3. SPRING
4. GOLD CONNECTER

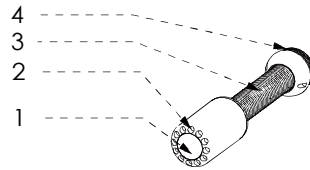

Figure 1: Camera Head

Cable wheel and push cable

1. ROTATION MECHANISM
2. HANDLE
3. CABLE CONNECTOR (TO CAMERA)
4. CABLE WHEEL
5. PUSH CABLE

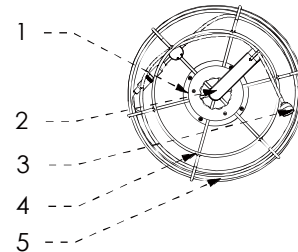

Figure 2: Cable wheel and push cable

Battery Pack

1. LED (battery level indicates)
2. POWER SWITCH
3. DC 12V RECHARGING
4. FUSE
5. USB OUTPUT (DC 5V)
6. DC 7,4V OUTPUT

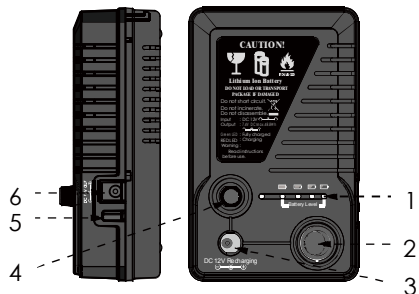

Figure 3: Battery Pack

Remote control

1. Mode: Select mode
2. Power: Power switch
3. Up: Select up/previous item
4. Left: Select left item
5. OK&Meun: Confirm/select menu
6. Right: Select right item
7. Down: Select down/next item
8. REC: Start/stop recording
9. Photo: Take Photo
10. Mirror: Mirror and flip image
11. "-": Lower the LED brightness
12. "+": Increase the LED brightness

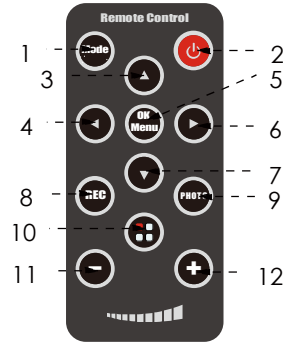

Figure 4: Remote control

DVR AND TOOL BOX

1. Power indicates
2. Mode
3. [REC] Down & record button
4. [Up] Up & mirror button
5. [OK] OK & menu button
6. [Left] Left & led "-" button
7. [Right] Right & led "+" button
8. [Power] Power switch & photo
9. IR for remote control
10. Color TFT LCD
11. DC IN
12. Video & audio out
13. Sun visor
14. SD card slot
15. To PC
16. Aviation socket
17. Remote control
18. DC 12V cable
19. Aviation cable
20. Camera head
21. Adapter & car charger

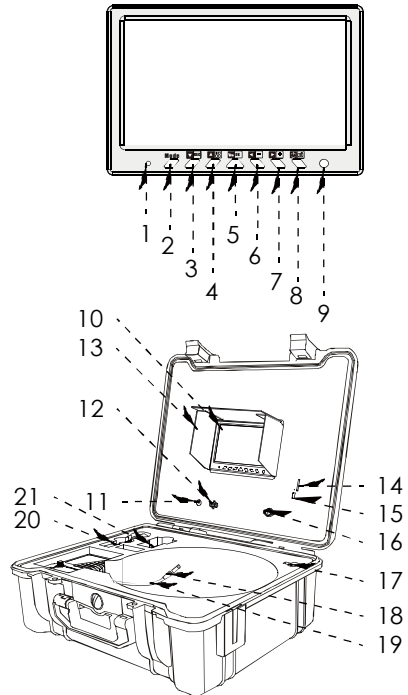

Figure 5: DVR AND TOOL BOX

DESCRIPTION SPECIFICATIONS AND STANDARD EQUIPMENT

Specifications

	Item	Parameter
General	Operating Temperature	-10~50°C/+14~+122°F
	Operating Humidity	30%RH~90%RH
	Storage Temperature	-20~60°C/+4~+140°F
	Power adapter	Input: AC 110V~240V , Output: DC 12V 1200mA
	Meas	57.5cm×26.5cm×52cm (L×W×H)
	Weight	10Kg(Approx)
Camera	Sensor	1/3" Sony CCD
	TV-Line	420 TV-Line
	View Angle	140°
	Focus Distance	20cm (approx)
	Depth-of-View	100cm(approx)
	Camera Size	φ23mm×45mm (Main body)
	Camera Length	120mm
	Front Lens	Sapphire
	Shell Material	304#Stainless Steel
	Lighting	Built-in 12×LED(White)
	Water-Proof	20m water (Camera fix on Cable)
	Power Supply	DC12V
	Current Consume	60mA(LED OFF); 140mA(LED ON)
DVR	Screen	7-inch 16:9 high-definition color LCD screen
	Resolution	800×480 RGB
	Mirror and Flip	Support image mirror, Flip, Mirror & Flip
	Video Resolution	PAL 720×576 25FPS Max; NTSC 720×488 30FPS Max
	Video Encoding	H.264
	Photograph	720×480/720×576
	Audio Recording	Local Sound
	Out Put	TV and Audio output
External Memory	Support SD Memory Card up to 32GB	

DVR	Data Output	USB2.0 To PC
	LED Driver	Built-in Dimmer
	Play Back	Video, Photo and Audio
	Language	English, German, French, Spanish, Italian, Chinese, Japanese, Russian, Portuguese
	Power Supply	DC 6~12V input
	Current Consume	700mA Max
Battery pack	Power Input	DC 9~12V input
	Battery Capacity	DC 7.4V 6600mAh Li-ion Battery
	Power Output	DC 6~12V& DC 5V
	Life Time	7 hour (Record) ,9 hour (Play Back)
	Charge Time	8 hour
Cabl Wheel	Cable Diameter	φ5.2mm
	Cable Length	20/30/40 meter (Selectable)
Tool box	Size	517×434×200mm(L×W×H)
	Box color	Black /Yellow (Selectable)

Package Contents

1. Toolbox with DVR
2. Remote control
3. Cable wheel and push cable
4. Operation manual
5. Battery pack and cable
6. Fuse (2x)
7. Car charger
8. Plastic skid
9. Ball guide (2x)
10. Camera
11. Screw (2x), nut (2x) and waterproof-ring
12. Adapters
13. Screwdriver

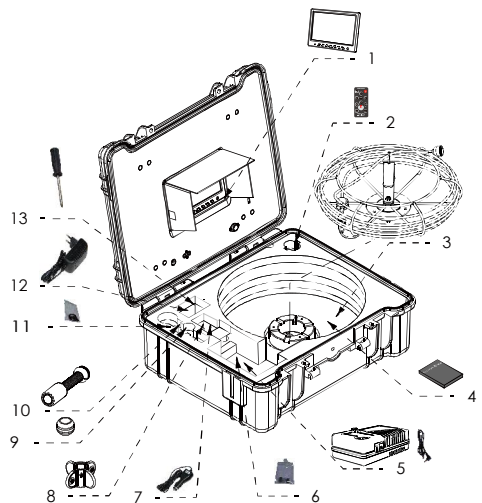

Figure 6: Package Contents

INSTALLATION

WARNING

To reduce the risk of serious injury during use, follow these procedures for proper assembly.

1. Install Camera Head

Put the cable into the hook of the handle, (Figure 7) Hold the cable connector in one hand, then screw the camera and fix it on the cable tightly.(Figure 8)

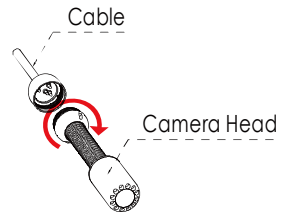
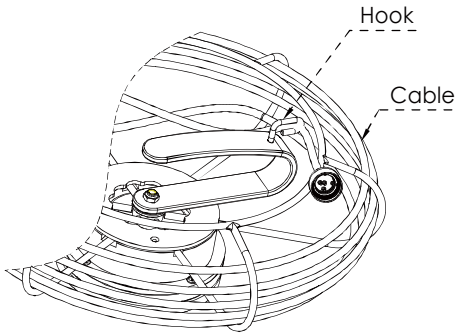

Figure 7: Cable reel in the case

Figure 8: Assembly/Disassembly Camera

2. Install aviation cable

Plug the cable into the socket of the panel and screw tightly.(Figure 9)

3. Install power cable

Connect the power cable to battery and panel .(Figure 10)

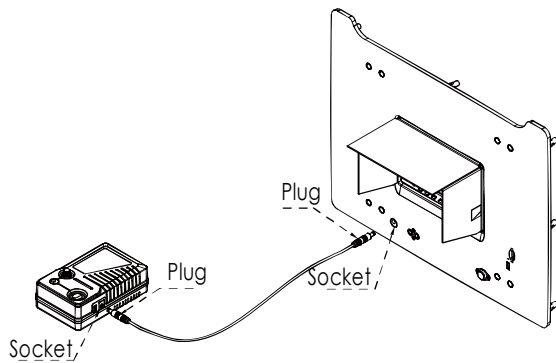
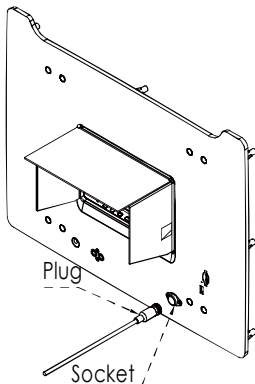

Figure 9: Install aviation cable

Figure 10: Install power cable

4. Install guide fitting

Ball guide and skid are designed to help position the camera towards the middle of the pipe. There are 2 kinds of guides, choose guides properly per application requirement.

A. Installing Ball Guides.

Sleeve the camera heads with ball guide. (Figure 11.)

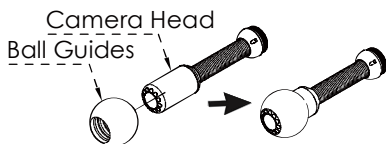

Figure 11: Install Ball Guides

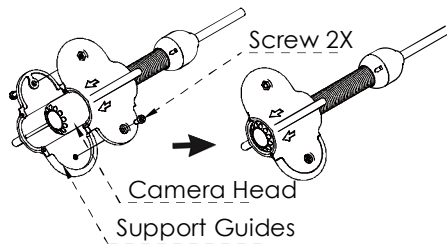

Figure 12: Install Support Guides

B. Install Support Guides.

Mount the support guide onto the stainless steel camera head. Then tighten the screw by screwdriver. (Figure 12.)

5. Install SD Card (Figure 13.)

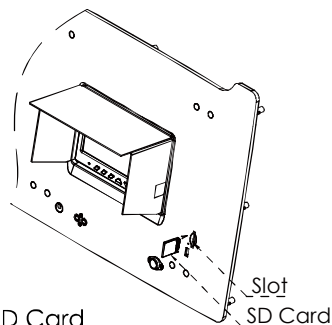

Figure 13: Install SD Card

6. Turn on the battery pack and DVR.

FUNCTION GUIDE AND OPERATING INSTRUCTIONS

DVR Icon

1. SD Card
2. Battery Level
3. Image Reverse
4. Image Reverse & Mirror
5. Image Mirror
6. Timestamp
7. LED Lighting
8. Record

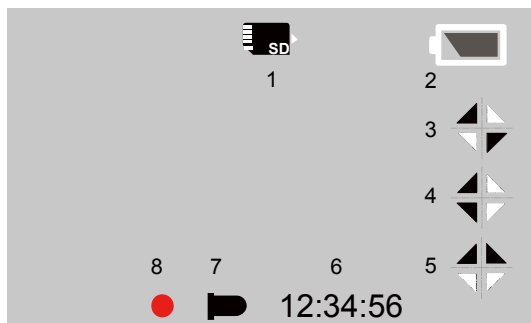















Figure 14: Screen icon Definition

FUNCTION GUIDE

1. Live video







- Press and hold [] for 2 seconds to turn on/off DVR to enter the live video mode, then press [**Mode**] to enter playback mode.
- Press [] to start/stop recording.
- Press [] to mirror or/and reverse the image.
- Press [] increase or decrease the brightness of camera LEDs.
- Press the [] to take a picture.

2. Video Option

- Press [] to enter the video option menu. Press [ ] to select items that you need, press [] to confirm the selection. Press [] or [] to change the value. Press [] to save the setting. Press [] to exit video option.

- 1) Size: D1(720*576)/VGA(640*480)/QVGA(320*240)
- 2) Video Seg: 10min/20min/30min/40min/OFF. Set 10-40min to restrict files length and open cycle-cover. Elder files will be covered by new files when SD card is full. Set OFF to close this function.
- 3) CH Loop: Wireless Video option. Not available for CCTV.
- 4) Time Stramp: Enable/Disable time stamp on screen.

3. Playback

- Press the [**Mode**] button to enter the playback, the user can browse, preview and playback media files.
- Press [] and [] to browse and select media files.
- Press [] to confirm the selection and preview media file. Press [] to preview the previous file. Press [] to preview the next file. Press [] to playback video. Press [] to enter the play setting.

- 1) Delete: Delete media files.
- 2) Slide Show: 3sec/5sec/10sec. To set interval time of the slide shows.
- 3) Protection: To protect important media files.
- 4) Thumbnail: Browse 9 media files per page.
- 5) File List: Browse 3 media files per page.
- 6) LCD: LCD brightness.

4. Playing Movie

- [] Pause/Play movie, [] Stop play movie, [] Rewind, [] Forward, you can press [] to set speed rate of rewind/forward.

5.SETUP

●Press [ OK] to enter the preferences of Record/Playback. Press [ +] enters Setup menu.

The following items are in the setup menu.

- 1) Format: format SD card.
- 2) LCD: LCD brightness.
- 3) Language: English, German, French, Spanish, Italian, Chinese, Japanese, Russian, Portuguese.
- 4) Sys. Reset: Reset all setting.
- 5) Light frequency,50Hz/60Hz, specifying your ambient light frequency.
- 6) TV output: PAL/NTSC.
- 7) Date input: To set date and time.
- 8) USB: PC Cam/Disk Driver. To set DVR works as a PC camera or disk driver when connect to PC.

At the Job Site

Always wear rubber gloves to operate the camera for health and safety reasons.

1. Properly positioning the cable reel will save time and strength to push out and in the cable, and minimize the rate of equipment damage.
 - a. When pushing, the end of your stroke should be as close to the entry as possible. Standing too far back with an excess of cable between your hands and the entry may cause the cable to fold on itself outside the entry and damage the cable.
 - b. Try to keep the push cable away from sharp edge of a pipe entry because this may cause damage. If the camera does not seem to go any farther, DO NOT FORCE TO PUSH THE CAMERA! Try another entry if possible.

NOTE! Hands should be close to the line opening. DONOT catch the cable on the edge of an entry and continue to push.

2. Always try to run water down the pipe under going inspection. This will keep the system much cleaner, and allow you to push noticeably farther with less friction. If the water is preventing you from seeing an area of importance, temporarily turn it off.
3. When push the push cable through the pipeline by steady and slowly, a short distance entry per time, keeps the hands at the entrance, so that can control the push cable and prevent it stuck, bent or scratch.
4. When inspecting a pipe, most of the time a slow steady push through the system works the best. At changes in direction such as P-traps, Tee's, Y's, Elbows, etc. It is usually necessary to give a little extra push in the bends. Back the camera head approximately 8" (20cm) from the bend,

if necessary, and give it a quick push, “popping” the camera through a turn, using the least amount of force required. Try to be as gentle as possible, and do not hammer or snap the camera head through corners. After some practice, you may learn that the best way to inspect a section of pipe is to push the camera through quickly. Then draw the camera back home slowly and evenly.

5. Make sure the sapphire window is clean prior to entry. Some users claim that a slight film of detergent on the lens minimizes the possibility of grease sticking to the port. If necessary, take advantage of any standing water in the pipe to wash the front of the camera by jiggling it in the water.
6. When you place the camera head into the pipe remember, as the materials of pipe vary, it will be necessary to adjust the lighting settings to maximize picture quality.
7. The system can travel through multiple 45 and 90 degree bends and eyes. Do not, however, try to force it through a P-trap or tee if there is a large amount of resistance.

NOTE! Do not try to use the camera head to clear obstructions. This System is a diagnostic tool, not a drain cleaner. Using the camera head to clear obstructions could damage the camera head or cause it to be caught in the obstruction.

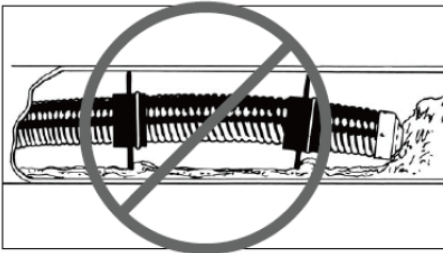

Figure 15: Improper operation

8. Do not attempt to remove or store push cable on the reel solely by turning the reel itself. You can manually push or pull cable from the reel and wind or unwind it.
9. If the camera sits in a pipe, or an enclosed environment, heat will build-up. This may lead to the camera head overheating which will cause fuzzy lines to appear on the monitor. In the event, this happens, turn off the system, remove the camera from the pipe (or enclosed environment) and let the camera head cool for 10 to 15 minutes. Running water into the line will also help cool the camera head. Always use the minimum illumination required to maximize picture quality and to avoid excessive heat build-up.

NOTE! The camera head can get HOT! When finished with your inspection, or if taking a prolonged break in the middle of the inspection, turn off the system.

Retrieving the push cable

1. Once the inspection has been completed, pull the push cable back with slow, steady force. Do not force the push cable or exert excessive force. This could damage the camera or push cable. The push cable may get hung up while being retrieved, and may need to be manipulated as did during insertion.
2. Continue running water down the line if possible to help clean the push cable. A towel can be used to wipe off the push cable as it is withdrawn.

Note! NEVER USE SOLVENTS to clean any part of the system. Substances like acetone and other harsh chemicals can cause cracking of the camera ring, which could affect waterproofing.

3. Storing the push cable into the cable reel. One hand holds the push cable, the other hand close to the cable wheel. Slowly and gently push the push cable slide via the hook of the handle, cable reel will rotate and store the push cable inside.

Note! The hands should be close to the cable wheel when storing the push cable. Push the push cable a small piece every try. Push a long distance can cause the push cable bend or broken.

BATTERY PACK SAFETY AND USING GUIDE

Using safety

Read the following battery precautions before using the battery and charger, to reduce the risk of electrical shock.

1. Recharge batteries with accessory charging units.
2. Check the power units and battery pack every time before using the equipment, be sure no problem, use of unauthorized parts may result in electrical shock, fire and/or serious personal injury or damage other instruments and system.
3. Never connects the car charger to any 24 volt cigarette lighter slot. It will harm the battery pack and DVR.
4. Do not short circuit, it may cause fire, electrical shock.
5. Do not charge the battery under rain or wet conditions. Water entering the charger will increase the risk of electrical shock.
6. If the charger and battery are damaged, do not use or stop to charge. It may cause electrical shock.

7. Don't disassemble the battery and case of power adapter, only qualified repair person can repair and maintenance.
8. Properly dispose of the battery. Exposure to high temperatures can cause the battery to explode. So do not dispose of in a fire. Some countries have regulations concerning battery disposal. Please follow all applicable regulations.
9. Do not touch anything which out from battery, which would burn or damage the skin, once touches please flush with water. If in eyes, immediately get medical help fast.

Using Guide

Follow the steps as below to reduce the injury of the electric shock.

1. Plug the power adapter to the AC outlet, and insert the other end into the DC inlet on top of the battery pack, charging LED will be red during charging, will be turned to green when charged fully. If battery empty for a long term, it will pre-charge the battery automatically in 10 minutes, and charging LED will be blinking in red.
2. Turn on the power of the battery pack, the battery will supply the system, the battery level will be displayed by the indicator, each green LED indicators mean 25% percent of the battery.
3. It needs about 8 hours to charge the battery fully. The battery can charge online, charging and supplying of work will not increase charging times.

Tips

User can use a power adaptor or car charger to charge the battery pack. Also can directly supply the system without battery pack.

If no use in a long term, take a recharge per 6 month, to ensure the battery in normal working status.

OTHERS

Troubleshooting

Problem	Probable fault location	Solution
No Battery Level indicate	No power completely	To charge the battery
	Fuse burned	Change the fuse
No image	Cableconnection faulty or loosely	Check cable connection, clean and reconnect if necessary
	Camera pin soiled	Clean the camera pin
	Wrong SD memory Card	Turn off battery pack , and change SD card

FCC

FCC Statement

This device complies with part 15 of the FCC Rules. Operation is subject to the following two conditions:

1. This device may not cause harmful interference.
2. This device must accept any interference received, including interference that may cause.

Undesired operation. Changes or modifications not expressly approved by the party responsible.

For compliance could void the user's authority to operate the equipment.

CE

This product complies with standards including Low Voltage Device Directive 73/23/EEC;

EMC

Directive 89/336/EEC. It passed the subject tests by the authority concerned and is authorized to bear CE mark.